



 HAWKE® | MIL PRO (20x)



OVERVIEW

Accurate mil spacing on 20× magnification. With half Mil spaced markings extending out to 8 Mil of holdover, the Mil Pro (20×) is a versatile reticle that provides aim points no matter how extreme the distance.

All reticle measurements are Mil spaced and offer 1 Mil, 0.5 Mil and 0.25 Mil brackets for range finding. Every second Mil spacing on the lower section is numbered to ensure quick and easy acquisition of target and ease of reference.

Each cross has a see-through gap, allowing an unobstructed view of the target. The thick outer posts are hollowed to ensure they can be seen at all magnifications, without blocking out too much of the view.



Mil Pro 20× models have additional $\frac{1}{4}$ Mil aim points on the center section of the reticle to give even greater precision.

SUBTENSIONS

MIL-MIL SETUP

When on 20× magnification, the Mil spaced reticle and $\frac{1}{10}$ MRAD turrets make for easy point of aim adjustment. Every 10 clicks on the turret will measure exactly 1 Mil spacing on the reticle, also known as 1 MRAD.

IMPERIAL

1 MRAD = 1yd @ 1000yds, or 3.6in @ 100yds. At different ranges this MRAD gap will change:
50yds = 1.8in, 100yds = 3.6in, 200yds = 7.2in, 300yds = 10.8in.

METRIC

1 MRAD = 1m @ 1000m, or 10cm @ 100m. At different ranges this MRAD gap will change:
50m = 5cm, 100m = 10cm, 200m = 20cm, 300m = 30cm.

ÜBERSICHT

Genauer Mil-Abstand bei 20facher Vergrößerung. Mit Markierungen im Halb-Mil-Abstand bis zu 8 Mil Haltepunkten nach oben ist das Mil Pro (20x) ein vielseitiges Absehen, das selbst unter extremsten Bedingungen Zielpunkte bietet.

Alle Absehenmaße haben Mil-Abstand sowie 1 Mil, 0,5 Mil und 0,25 Mil Markierungen zur Entfernungsmessung. Jeder zweite Mil-Abstand im unteren Abschnitt ist nummeriert, um eine rasche und einfache Zielerfassung mit guter Übersichtlichkeit zu gewährleisten.



Jedes Kreuz ist durchsichtig und erlaubt somit einen ungehinderten Blick auf das Ziel. Die dicken äußeren Linien sind Hohllinien, damit sie bei allen Vergrößerungen sichtbar sind, ohne die Sicht zu behindern.

Das Mil Pro (20×) weist zur Steigerung der Präzision zusätzliche $\frac{1}{4}$ Mil Haltepunkte im inneren Bereich des Absehens auf.

ABDECKUNGEN

MIL-MIL-SETUP

Bei 20× Vergrößerung ist die Justierung der Trefferlage dank Mil-Absehen und $\frac{1}{10}$ MRAD Türme besonders leicht. Zehn Einstellschritte des Turms entsprechen exakt dem Abstand von 1 Mil (1 MRAD) im Absehen.

ZÖLLIG

1 MRAD = 1 yd bei 1000 yds, oder 3,6 in bei 100 yds. Für unterschiedliche Entfernungen ändern sich diese MRAD-Lücke: 50 yds = 1,8 in, 100 yds = 3,6 in, 200 yds = 7,2 in, 300 yds = 10,8 in.

METRISCH

1 MRAD = 1m bei 1000m, oder 10cm bei 100m Für unterschiedliche Entfernungen ändern sich diese MRAD-Lücke: 50 m = 5cm, 100 m = 10cm, 200 m = 20cm, 300 m = 30cm.

PRÉSENTATION GÉNÉRALE

Espacement précis en mil avec un grossissement 20×. Avec un marquage espacé tous les demi Mil s'étendant jusqu'à 8 Mil de correction en hauteur, le réticule Mil Pro (20×) est un réticule polyvalent fournissant des points de visée, même pour des distances extrêmes.



Les mesures du réticule sont espacées tous les Mil, et elles offrent des segments 1 Mil, 0,5 Mil et 0,25 Mil pour la télémétrie. Toutes les secondes, l'espacement Mil sur la section inférieure est numéroté afin d'assurer l'acquisition rapide et facile de la cible et pour faciliter la référence.

Chaque croix comporte un intervalle transparent, donnant un champ de vision non-obstrué sur la cible. Les montants extérieurs épais sont creux pour être visibles avec tous les grossissements, sans trop bloquer le champ de vision.

Le modèle Mil Pro (20x) dispose de repères de visée $\frac{1}{4}$ Mil additionnels sur le trait central du réticule, pour assurer une précision encore meilleure.

SUBTENSIONS

CONFIGURATION MIL-MIL

En grossissement 20×, le réticule à repères espacés d'un Mil et les tourelles $\frac{1}{10}$ MRAD facilitent l'ajustement du point de visée. 10 clics sur la tourelle correspondent exactement à un décalage d'un Mil sur le réticule, également connu sous l'appellation 1 MRAD.

IMPERIAL (Unités anglo-saxonnes)

1 MRAD = 1yd @ 1000yds, ou 3.6in @ 100yds. À des distances différentes, cet intervalle MRAD variera. 50yds = 1.8in, 100yds = 3.6in, 200yds = 7.2in, 300yds = 10.8in.



METRIC (Unités métriques)

1 MRAD = 1m @ 1000 m, ou 10 cm @ 100 m À des distances différentes, cet intervalle MRAD variera. 50 m = 5 cm, 100 m = 10 cm, 200 m = 20 cm, 300 m = 30 cm.

RESUMEN

Espaciado de milirradiantes preciso con aumento de 20×. Con marcas espaciadas cada medio Milirradián, que llegan hasta los 8 Milirradiantes desde el punto de compensación, la Mil Pro (20×) es una retícula versátil que ofrece puntos de mira para las distancias más extremas.

Todas las mediciones de la retícula están espaciadas a un Milirradián y ofrecen horquillas de telemetría a 1 Milirradián, a 0,5 Milirradián y a 0,25 Milirradiantes. Uno de cada dos espaciados

de Milirradiantes de la parte inferior están numerado para garantizar una adquisición de objetivo fácil y rápida y una referencia sencilla.

Todos los cruces cuentan con un espacio que permite ver lo que hay detrás, lo que garantiza una visión del objetivo sin obstrucciones. Los postes exteriores gruesos son huecos para garantizar que se puedan ver con todos los aumentos, sin bloquear en exceso la vista.

El Mil Pro (20×) cuenta con puntos de mira de $\frac{1}{4}$ Mil adicionales en la parte central de la retícula para una precisión aún mayor.



COBERTURA

CONFIGURACIÓN MIL-MIL

Las retículas espaciadas en Milirradiantes y las torretas $\frac{1}{10}$ MRAD ofrecen un ajuste sencillo del punto de mira. 10 clics de la torreta equivalen exactamente a un espaciado de 1 Milirradián en la retícula, también conocido como 1 MRAD. Dado que se trata de un sistema de primer plano focal, esto es aplicable a cualquier aumento.

SISTEMA IMPERIAL

Con un nivel de aumento de $20\times$, la retícula con intervalos de un Mil y las torretas de $\frac{1}{10}$ MRAD contribuyen a facilitar el ajuste del punto de mira. 10 clics en la torreta equivalen exactamente a un intervalo de 1 Mil en la retícula, una unidad de medida también conocida como 1 MRAD.

SISTEMA MÉTRICO

1 MRAD = 1m a 1000m, o 10cm a 100m. Estos espaciados MRAD van cambiando según el rango:
50 m = 5cm, 100 m = 10cm, 200 m = 20cm, 300 m = 30cm.

INTRODUZIONE

Precisa spaziatura in mil con ingrandimento 20x. Con metà dei contrassegni Mil spaziatì che si estendono a 8 Mil in brandeggio, il reticolo Mil Pro (20x) risulta altamente versatile e fornisce punti di mira anche alle distanze più estreme.

Tutte le misurazioni del reticolo utilizzano la spaziatura in Mil e offrono contrassegni di 1 Mil, 0,5 Mil e 0,25 Mil per il calcolo delle distanze. La sezione inferiore mostra un numero ogni due spaziature in Mil, per un'acquisizione rapida e semplice del bersaglio e per facile riferimento.



Ogni crocino presenta uno spazio trasparente, per non bloccare la visuale del bersaglio. Le spesse radici esterne sono cave, per risultare visibili a tutti gli ingrandimenti senza bloccare eccessivamente la visuale.

Il Mil Pro (20x) possiede ulteriori punti di mira da $\frac{1}{4}$ Mil sulla sezione centrale del reticolo per fornire una precisione ancora maggiore.

SOTTOTENSIONI

IMPOSTAZIONE MIL/MIL

Con un ingrandimento 20x, il reticolo spaziato in Mil e le torrette $\frac{1}{10}$ MRAD, facilitano la regolazione del punto di mira. 10 scatti sulla torretta equivalgono esattamente a una spaziatura di 1 Mil sul reticolo, chiamata anche 1 MRAD.



SISTEMA IMPERIALE BRITANNICO

1 MRAD = 1 iarda a 1000 iarde, o 3,6 pollici a 100 iarde. A distanze diverse, questo spazio MRAD cambierà: 50 iarde = 1,8 pollici, 100 iarde = 3,6 pollici, 200 iarde = 7,2 pollici, 300 iarde = 10,8 pollici.

SISTEMA METRICO DECIMALE

1 MRAD = 1m a 1000m, o 10cm a 100m. A distanze diverse, questo spazio MRAD cambierà: 50 m = 5cm, 100 m = 10cm, 200 m = 20cm, 300 m = 30cm.

Correct on
20× magnification

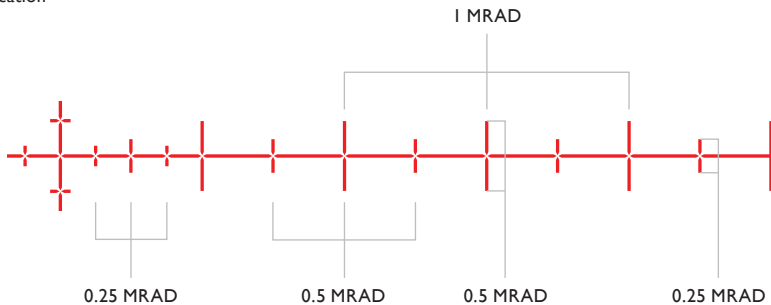

Correct on
20× magnification

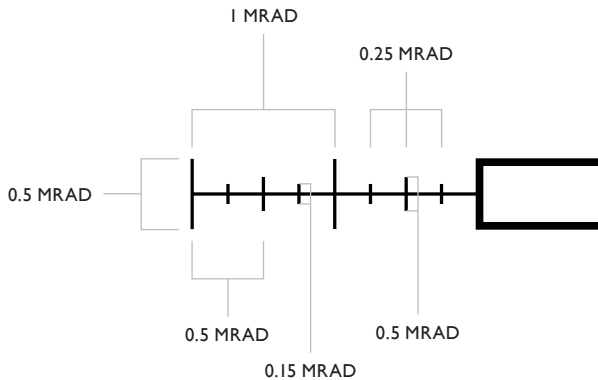

Correct on
20× magnification

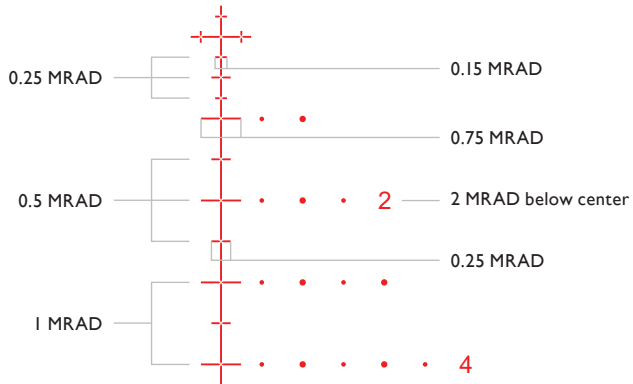

Correct on
20× magnification

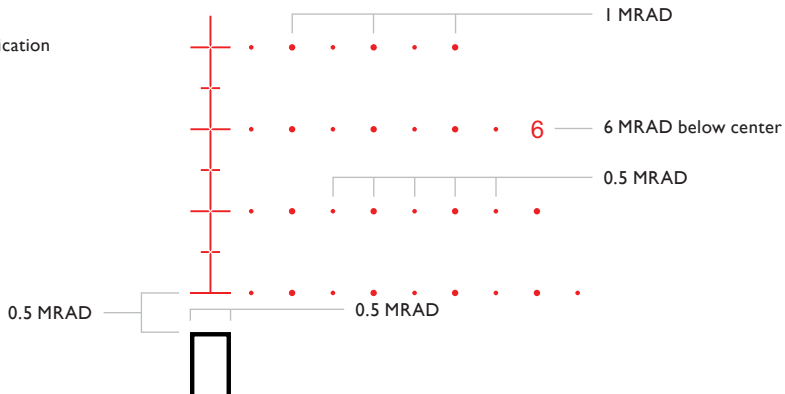

.223 REM CENTERFIRE

Magnification: 20×
Muzzle Velocity: 3240fps
Ballistic Coefficient: 0.2135
Zero Range: 100yds

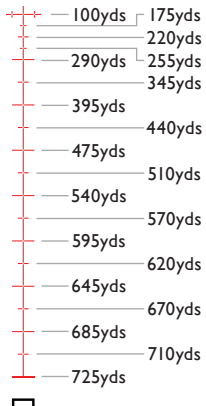

.223 REM CENTERFIRE

Magnification: 20×
Muzzle Velocity: 988m/s
Ballistic Coefficient: 0.2135
Zero Range: 100m

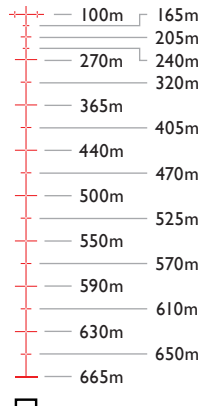

.243 WIN CENTERFIRE

Magnification: 20×
Muzzle Velocity: 2960fps
Ballistic Coefficient: 0.3691
Zero Range: 100yds

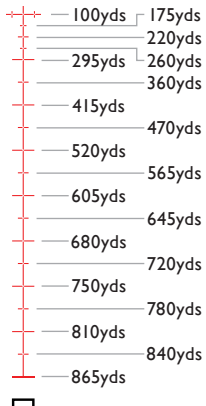

.243 WIN CENTERFIRE

Magnification: 20×
Muzzle Velocity: 902m/s
Ballistic Coefficient: 0.3691
Zero Range: 100m

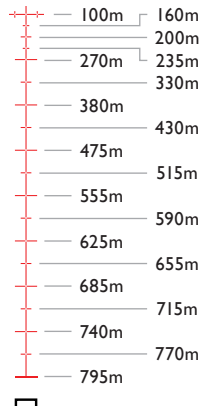

.308 WIN CENTERFIRE

Magnification: 20×
Muzzle Velocity: 2820fps
Ballistic Coefficient: 0.3208
Zero Range: 100yds

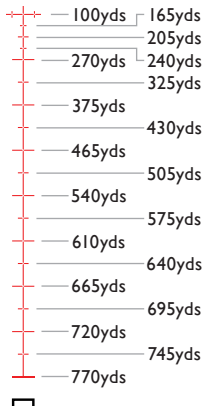

.308 WIN CENTERFIRE

Magnification: 20×
Muzzle Velocity: 860m/s
Ballistic Coefficient: 0.3208
Zero Range: 100m

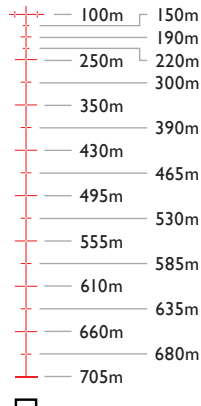

.17 HMR RIMFIRE

Magnification: 20×
Muzzle Velocity: 2550fps
Ballistic Coefficient: 0.1251
Zero Range: 100yds

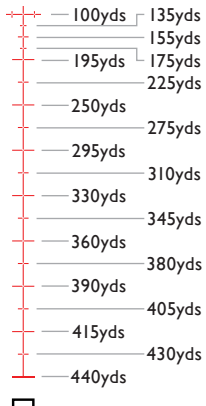

.17 HMR RIMFIRE

Magnification: 20×
Muzzle Velocity: 777m/s
Ballistic Coefficient: 0.1251
Zero Range: 100m



.22 LR HV RIMFIRE

Magnification: 20×
Muzzle Velocity: 1260fps
Ballistic Coefficient: 0.1300
Zero Range: 50yds

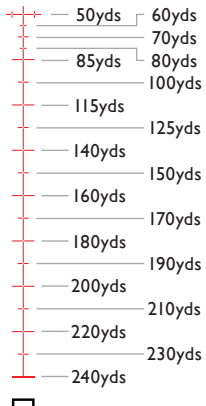

.22 LR HV RIMFIRE

Magnification: 20×
Muzzle Velocity: 384m/s
Ballistic Coefficient: 0.1300
Zero Range: 50m

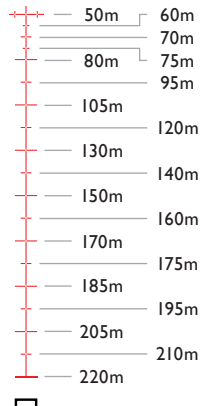

.22 LR SUB RIMFIRE

Magnification: 20×
Muzzle Velocity: 1057fps
Ballistic Coefficient: 0.1300
Zero Range: 50yds

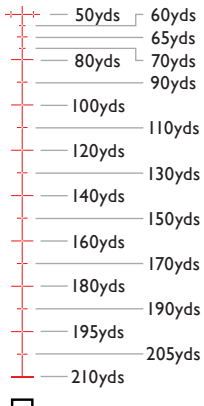

.22 LR SUB RIMFIRE

Magnification: 20×
Muzzle Velocity: 322m/s
Ballistic Coefficient: 0.1300
Zero Range: 50m

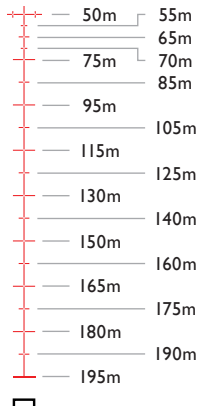

.22 AIRGUN (12ft/lb)

Magnification: 20×
Muzzle Velocity: 560fps
Ballistic Coefficient: 0.0183
Zero Range: 25yds



.22 AIRGUN (16 Joules)

Magnification: 20×
Muzzle Velocity: 171m/s
Ballistic Coefficient: 0.0183
Zero Range: 30m



.177 AIRGUN (12ft/lb)

Magnification: 20×
Muzzle Velocity: 786fps
Ballistic Coefficient: 0.0193
Zero Range: 30yds

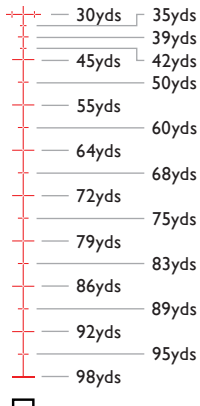

.177 AIRGUN (16 Joules)

Magnification: 20×
Muzzle Velocity: 240m/s
Ballistic Coefficient: 0.0193
Zero Range: 25m

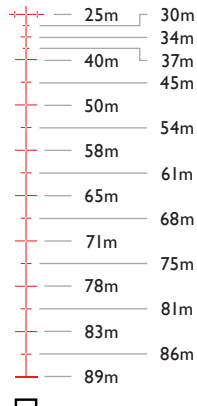



VISION ACCOMPLISHED

www.hawkeoptics.com

 Born in the UK